

# FLIQ 200.2027.01/DALI

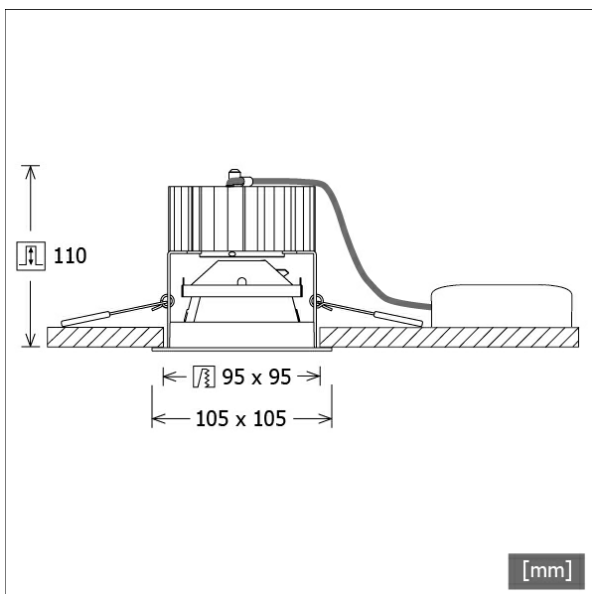

Farbe	Artikelnummer	EAN
schwarz	647594	4043544548320
silber	647595	4043544548337
weiß	647596	4043544548344



## Beschreibung

- Einbau-Downlight mit optischen Designvarianten für Allgemeinbeleuchtung
- hohe Wartungsfreundlichkeit
- keine UV- und Wärmestrahlung
- innovatives Wärmemanagement mit Passivkühlung (Kühlkörper aus Aluminium)
- entspiegelter Mattreflektor aus Aluminium für maximale Lichtausbeute und optimale Entblendung
- Front-/Einbaurahmen aus Zinkdruckguss mit Lichteffektrahmen klar (weitere Dekor-/Lichteffektrahmen und Dekogläser sind als Option erhältlich)
- werkzeugloser Deckeneinbau mit Schnellspannfedern (automatische Anpassung der Deckenstärke)
- Anschluss an Betriebsgerät über Leuchtenkabel mit Mini-Clamp Steckverbindung
- Betriebsgerät (LED-Konverter DALI, dimmbar) inklusive (Platzierung extern)

## Standardoptionen



## Sonderoptionen



## Lichttechnik / Normen

Leuchtmittel	LED Spot / CRI 80 / 2700 K
EPREL Lichtquellen	848120
Lebensdauer	L90 B50 50.000 h L80 B50 100.000 h L80 B20 50.000 h
Systemleistung	27.0 W
Leuchten-Lichtstrom	max. 2540 lm
Systemeffizienz	88.51 lm/W
Moduleffizienz	127.18 lm/W
UGR Klasse	>28
Abstrahlwinkel	70°
Versorgungsspannung	220 - 240 V / 50 - 60 Hz
Schutzklasse	III
Schutzart	IP20

## Abmessungen / Gewichte

Länge	105 mm
Breite	105 mm
Höhe	112 mm
Ausschnittsmaß (LxB))	95 x 95 mm
Deckenstärke	1.0 - 25.0 mm
Einbautiefe	110 mm
Nettogewicht	0.75 kg
Bruttogewicht	0.80 kg

# FLIQ 200.2027.01/DALI

Flixx 200 Square (FLIQZ 200.24, 1xLED 27W 827/2700K 2390lm 70 °)

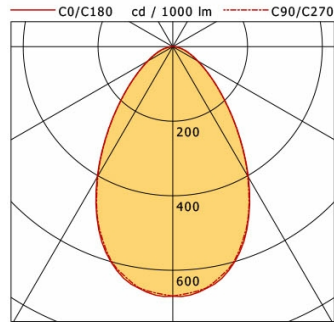

	C0	C90	C180	C270
0°	670	670	670	670
15°	610	607	610	607
30°	404	401	404	401
45°	189	188	189	188
60°	78	78	78	78
75°	29	29	29	29
90°	1	1	1	1
cd / 1000 lm				

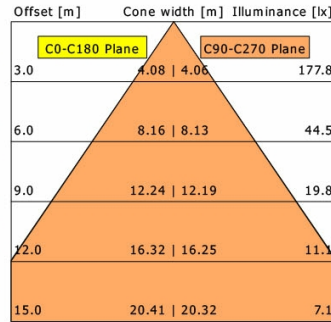

<b>η</b>	LED
Efficiency	89 lm/W
Direct/Indirect	↓ 100% / ↑ 0%
System Power	27 W
<b>UGR</b>	X=4H, Y=8H
Reflection factors	70/50/20
UGR C0/C180	29.0
UGR C90/C270	29.0
CIE Flux Codes	69 90 98 100 100
Ra/CRI	>80

LTS

Flixx 200 Square (FLIQZ 200.25, 1xLED 27W 827/2700K 2490lm 70 °)

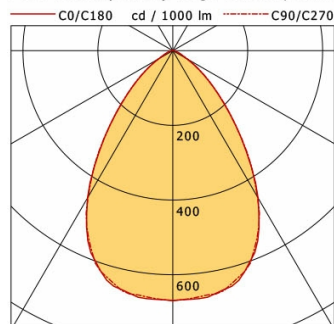

	C0	C90	C180	C270
0°	669	669	669	669
15°	646	638	646	638
30°	455	453	455	453
45°	183	186	183	186
60°	43	46	43	46
75°	11	11	11	11
90°	1	1	1	1
cd / 1000 lm				

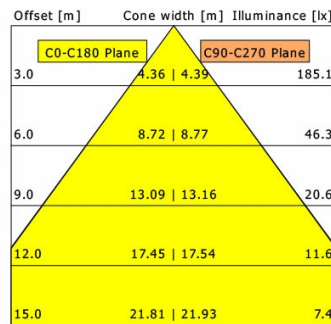

<b>η</b>	LED
Efficiency	92 lm/W
Direct/Indirect	↓ 100% / ↑ 0%
System Power	27 W
<b>UGR</b>	X=4H, Y=8H
Reflection factors	70/50/20
UGR C0/C180	26.2
UGR C90/C270	26.3
CIE Flux Codes	77 96 99 100 100
Ra/CRI	>80

LTS

Flixx 200 Square (FLIQZ 200.05, 1xLED 27W 827/2700K 2540lm 70 °)

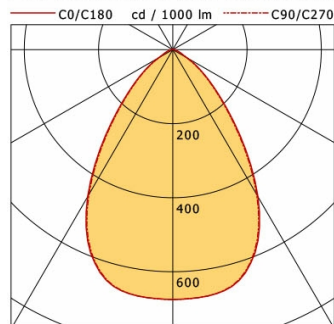

	C0	C90	C180	C270
0°	675	675	675	675
15°	654	653	654	653
30°	459	452	459	452
45°	180	174	180	174
60°	45	43	45	43
75°	12	12	12	12
90°	0	0	0	0
cd / 1000 lm				

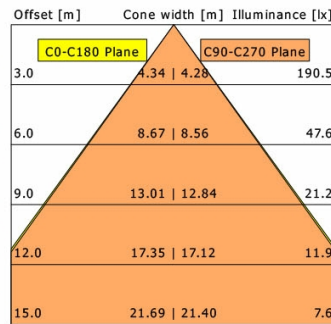

<b>η</b>	LED
Efficiency	94 lm/W
Direct/Indirect	↓ 100% / ↑ 0%
System Power	27 W
<b>UGR</b>	X=4H, Y=8H
Reflection factors	70/50/20
UGR C0/C180	26.3
UGR C90/C270	26.2
CIE Flux Codes	77 96 99 100 100
Ra/CRI	>80

LTS

# FLIQ 200.2027.01/DALI

## Zubehör



**FLIQZ 200.01**  
Dekorrahmen schwarz



**FLIQZ 200.02**  
Dekorrahmen silber



**FLIQZ 200.03**  
Dekorrahmen weiß



**FLIQZ 200.04**  
Lichteffektrahmen opal



**FLIQZ 200.05**  
Lichteffektrahmen klar



**FLIQZ 200.06**  
Lichteffektrahmen rot matt



**FLIQZ 200.07**  
Lichteffektrahmen gelb matt



**FLIQZ 200.08**  
Lichteffektrahmen blau matt



**FLIQZ 200.16**  
Lichteffektrahmen rot transluzent



**FLIQZ 200.17**  
Lichteffektrahmen gelb transluzent



**FLIQZ 200.18**  
Lichteffektrahmen blau transluzent



**FLIQZ 200.24**  
Dekoglas opal



**FLIQZ 200.25**  
Dekoglas klar