

ML-P 060.10840.3 19W/DALI

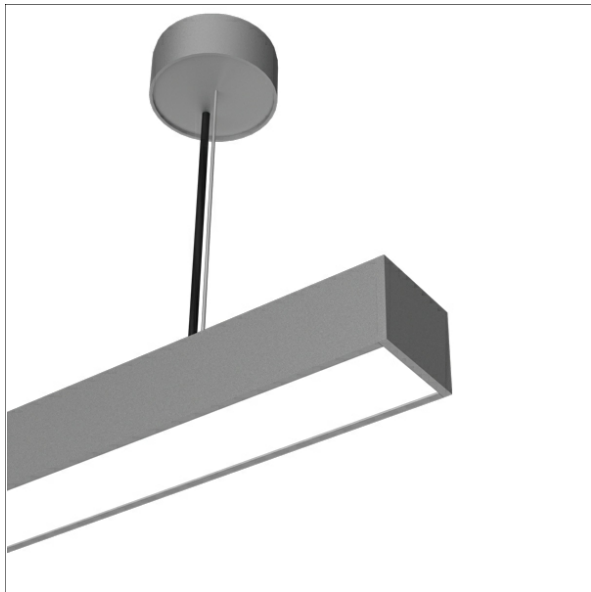

Farbe	Artikelnummer	EAN
silber eloxiert	670588	4043544822550
schwarz	670589	4043544822567
weiß	670590	4043544822574

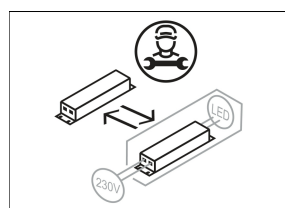
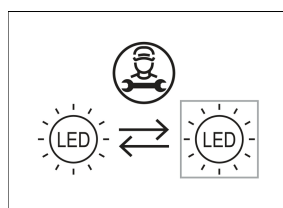
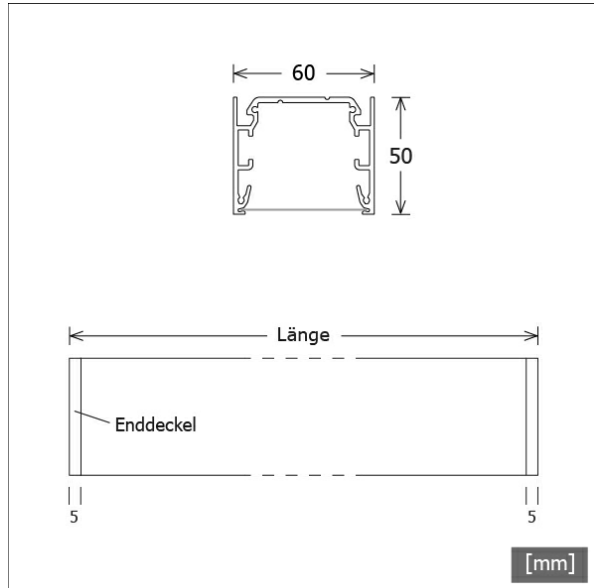

Beschreibung

- filigrane Linearleuchte für Pendelmontage und 360° blendfreie Arbeitsplatzbeleuchtung (UGR < 19)
- hohe Wartungsfreundlichkeit
- keine UV- und Wärmestrahlung
- Gehäuse aus Aluminium
- Enddeckel aus Polycarbonat
- Lichtlenkungsfolie nanoOptix "breitstrahlend" aus klarem Polycarbonat mit doppelt asymmetrischer Lichtverteilung
- höhenverstellbare Drahtseilabhängung 2-fach (Länge: 3000 mm)
- Betriebsgerät (LED-Konverter DALI, dimmbar) integriert

Hinweise

ACHTUNG: Die thermische Längenausdehnung des Aluminiumprofils beträgt bei $dT = 10$ Kelvin 0.3 mm pro Meter.

Standardoptionen



Sonderoptionen



Lichttechnik / Normen

Leuchtmittel	LED linear / CRI 80 / 4000 K
Lebensdauer	L90 B50 50.000 h L80 B50 100.000 h L80 B20 50.000 h
Systemleistung	15.1 W
Leuchten-Lichtstrom	2330 lm
Systemeffizienz	154.30 lm/W
Moduleffizienz	205.00 lm/W
UGR Klasse	≤19
Versorgungsspannung	220 - 240 V / 50 - 60 Hz
Schutzklasse	I
Schutzart	IP20

Abmessungen / Gewichte

Länge	1420 mm
Breite	60 mm
Höhe	50 mm
Nettogewicht	3.92 kg
Bruttogewicht	4.44 kg

Control Arbeitsplatzleuchten

ML-P 060.10840.3 19W/DALI

ML-P 060.10840.3 19W/DALI

Monoline 060 | Pendant | Glare Control (1xLED 15W 840/4000K 2330lm)

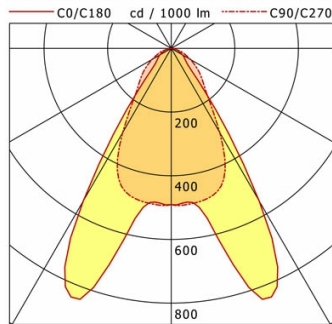

	C0	C90	C180	C270
0°	491	491	491	491
15°	663	482	663	482
30°	553	306	553	306
45°	75	138	75	138
60°	41	69	41	69
75°	17	23	17	23
90°	0	0	0	0

cd / 1000 lm

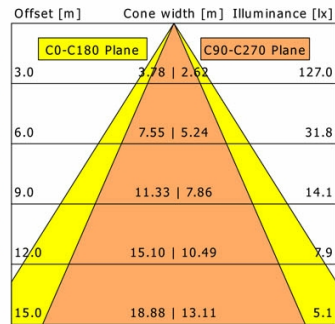

η	LED
Efficiency	155 lm/W
Direct/Indirect	↓ 100% / ↑ 0%
System Power	15 W
UGR	X=4H, Y=8H
Reflection factors	70/50/20
UGR C0/C180	16.9
UGR C90/C270	19.4
CIE Flux Codes	77 94 99 100 100
Ra/CRI	>80

LTS

Zubehör



ZB-OR DONGLE
Organic Response IR-Dongle-Set



ZB-OR GATEWAY
Organic Response IoT-Gateway Kaskadenserie



ZB-OR-A SENSOR
Organic Response Sensor für Anbaumontage



ZB-OR-P SENSOR/3000
Organic Response Sensor für Pendelmontage