

ML-P 060.10830.2 AOV/DALI

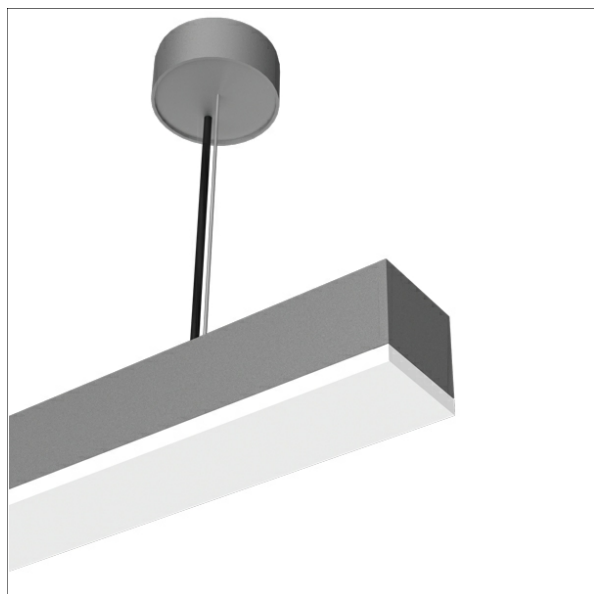

Beschreibung

- filigrane Linearleuchte für Pendelmontage
- symmetrische Lichtverteilung und gleichmäßig flächige Ausleuchtung
- hohe Wartungsfreundlichkeit
- keine UV- und Wärmestrahlung
- Gehäuse aus Aluminium
- Enddeckel aus Polycarbonat
- Acrylglasdiffusor opal vorgesetzt (10 mm) aus PMMA mit werkzeugloser Einrasttechnik
- höhenverstellbare Drahtseilabhangung 2-fach (Lange: 3000 mm)
- Betriebsgerat (LED-Konverter DALI, dimmbar) integriert

Hinweise

ACHTUNG: Die thermische Langenausdehnung des Aluminiumprofils betragt bei $dT = 10$ Kelvin 0.3 mm pro Meter.

Standardoptionen



Farbe	Artikelnummer	EAN
silber eloxiert	670555	4043544822222
schwarz	670556	4043544822239
wei	670557	4043544822246

Sonderoptionen



Lichttechnik / Normen

Leuchtmittel	LED linear / CRI 80 / 3000 K
Lebensdauer	L90 B50 50.000 h L80 B50 100.000 h L80 B20 50.000 h
Systemleistung	16.5 W
Leuchten-Lichtstrom	2460 lm
Systemeffizienz	149.09 lm/W
Moduleffizienz	193.00 lm/W
UGR Klasse	≤25
Versorgungsspannung	220 - 240 V / 50 - 60 Hz
Schutzklasse	I
Schutzart	IP40

Abmessungen / Gewichte

Lange	1140 mm
Breite	60 mm
Hohe	60 mm
Nettogewicht	3.72 kg
Bruttogewicht	4.14 kg

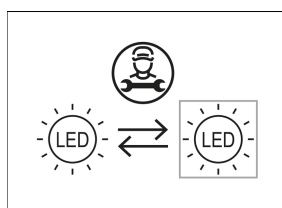
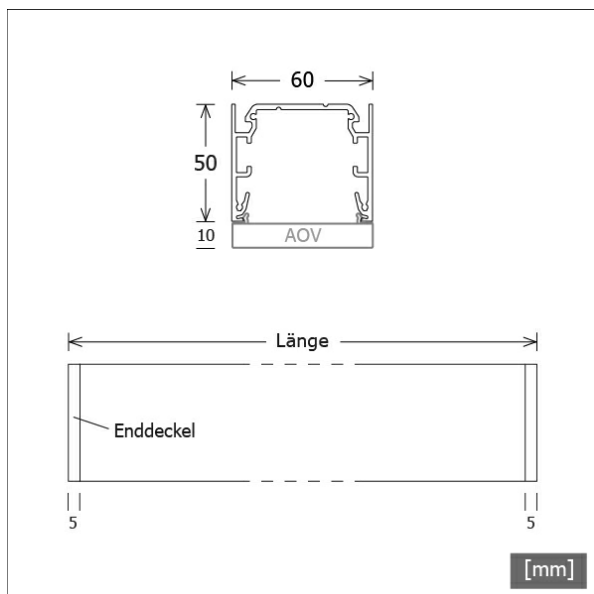

ML-P 060.10830.2 AOV/DALI

ML-P 060.10830.2 AOV/DALI

Monoline 060 | Pendant (1xLED 17W 830/3000K 2460lm)

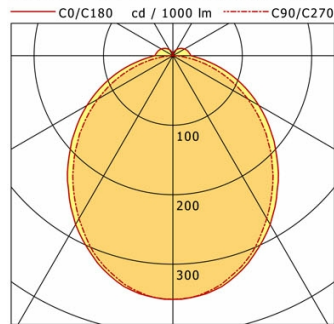

	C0	C90	C180	C270
0°	351	351	351	351
15°	332	328	332	328
30°	280	271	280	271
45°	213	200	213	200
60°	143	125	143	125
75°	74	51	74	51
90°	26	1	26	1
cd / 1000 lm				

Offset [m]	Cone width [m]		Illuminance [lx]
3.0	7.97	7.16	95.8
6.0	15.93	14.33	24.0
9.0	23.90	21.49	10.6
12.0	31.86	28.66	6.0
15.0	39.83	35.82	3.8

η	LED
Efficiency	145 lm/W
Direct/Indirect	↓ 93% / ↑ 7%
System Power	17 W
UGR	X=4H, Y=8H
Reflection factors	70/50/20
UGR C0/C180	23.6
UGR C90/C270	22.9
CIE Flux Codes	48 78 94 93 100
Ra/CRI	>80

LTS

Zubehör



ZB-OR DONGLE
Organic Response IR-Dongle-Set



ZB-OR GATEWAY
Organic Response IoT-Gateway Kaskadenserie



ZB-OR-A SENSOR
Organic Response Sensor für Anbaumontage



ZB-OR-P SENSOR/3000
Organic Response Sensor für Pendelmontage