

FLIR-F 300.3030.01/DALI

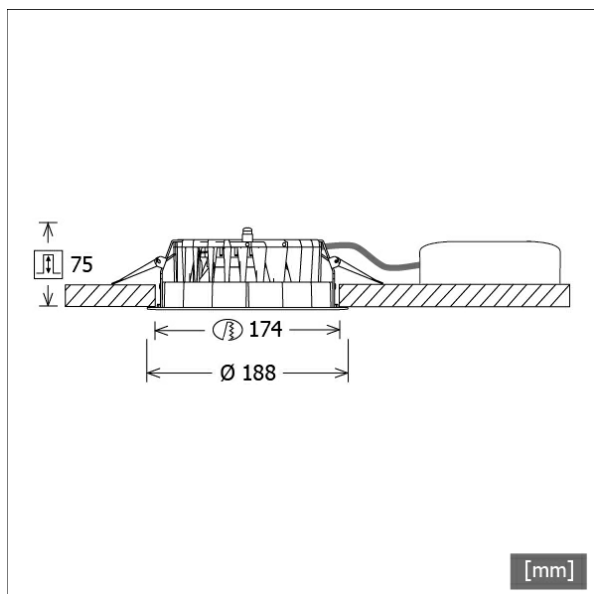

Farbe	Artikelnummer	EAN
schwarz	651634	4043544604040
silber	651635	4043544604057
weiß	651636	4043544604064



Beschreibung

- Einbau-Downlight mit optischen Designvarianten für Allgemeinbeleuchtung
- sehr geringe Einbautiefe
- hohe Wartungsfreundlichkeit
- keine UV- und Wärmestrahlung
- innovatives Wärmemanagement mit Passivkühlung (Kühlkörper aus Aluminiumdruckguss)
- High-Performance Spiegelreflektor aus Aluminium mit präziser symmetrischer Abstrahlcharakteristik für maximale Lichtausbeute und optimale Entblendung
- Front-/Einbauring aus Zinkdruckguss mit Lichteffektring klar (weitere Dekor-/Lichteffektringe und Dekogläser sind als Option erhältlich)
- werkzeugloser Deckeneinbau mit Schnellspannern (automatische Anpassung der Deckenstärke)
- Anschluss an Betriebsgerät über vormontiertes Leuchtenkabel
- Betriebsgerät (LED-Konverter DALI, dimmbar) inklusive (Platzierung extern)

Standardoptionen



Sonderoptionen



Lichttechnik / Normen

Leuchtmittel	LED Modul / CRI 80 / 3000 K
EPREL Lichtquellen	891018
Lebensdauer	L90 B50 50.000 h L80 B50 100.000 h L80 B20 50.000 h
Systemleistung	29.0 W
Leuchten-Lichtstrom	max. 2810 lm
Systemeffizienz	94.13 lm/W
Moduleffizienz	119.10 lm/W
UGR Klasse	≤28
Abstrahlwinkel	85°
Versorgungsspannung	220 - 240 V / 50 - 60 Hz
Schutzklasse	III
Schutzart	IP20

Abmessungen / Gewichte

Außendurchmesser	188 mm
Höhe	77 mm
Ausschnittsmaß (∅)	174 mm
Deckenstärke	5.0 - 40.0 mm
Einbautiefe	75 mm
Nettogewicht	1.13 kg
Bruttogewicht	1.19 kg

FLIR-F 300.3030.01/DALI

Flixx 300 Flat Round (FLIRZ 300.25, 1xLED 29W 830/3000K 2730lm 85 °)

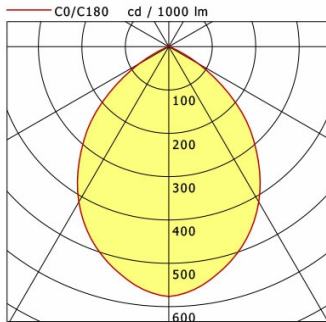

	C0	C90	C180	C270
0°	577	577	577	577
15°	521	521	521	521
30°	414	414	414	414
45°	261	261	261	261
60°	79	79	79	79
75°	4	4	4	4
90°	0	0	0	0

cd / 1000 lm

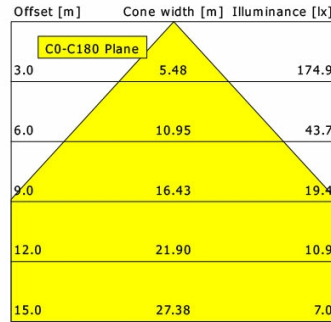

η	LED
Efficiency	94 lm/W
Direct/Indirect	↓ 100% / ↑ 0%
System Power	29 W
UGR	X=4H, Y=8H
Reflection factors	70/50/20
UGR C0/C180	24.7
UGR C90/C270	24.7
CIE Flux Codes	67 96 100 100 100
Ra/CRI	>80

LTS

Flixx 300 Flat Round (FLIRZ 300.24, 1xLED 29W 830/3000K 2620lm 85 °)

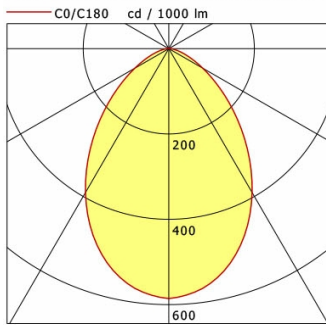

	C0	C90	C180	C270
0°	586	586	586	586
15°	530	530	530	530
30°	389	389	389	389
45°	221	221	221	221
60°	92	92	92	92
75°	27	27	27	27
90°	0	0	0	0

cd / 1000 lm

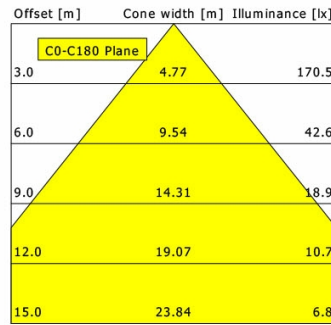

η	LED
Efficiency	90 lm/W
Direct/Indirect	↓ 100% / ↑ 0%
System Power	29 W
UGR	X=4H, Y=8H
Reflection factors	70/50/20
UGR C0/C180	26.1
UGR C90/C270	26.1
CIE Flux Codes	64 90 98 100 100
Ra/CRI	>80

LTS

Flixx 300 Flat Round (FLIRZ 300.05, 1xLED 29W 830/3000K 2810lm 85 °)

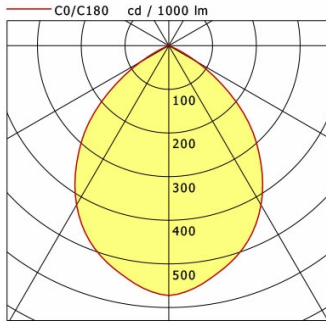

	C0	C90	C180	C270
0°	573	573	573	573
15°	520	520	520	520
30°	421	421	421	421
45°	266	266	266	266
60°	74	74	74	74
75°	1	1	1	1
90°	0	0	0	0

cd / 1000 lm

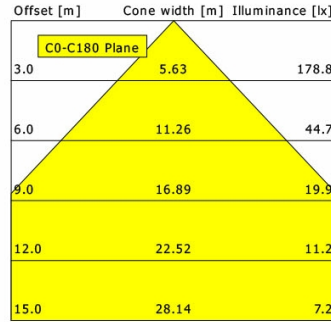

η	LED
Efficiency	97 lm/W
Direct/Indirect	↓ 100% / ↑ 0%
System Power	29 W
UGR	X=4H, Y=8H
Reflection factors	70/50/20
UGR C0/C180	24.7
UGR C90/C270	24.7
CIE Flux Codes	68 97 100 100 100
Ra/CRI	>80

LTS

FLIR-F 300.3030.01/DALI

Zubehör



FLIRZ 300.01
Dekorring schwarz



FLIRZ 300.02
Dekorring silber



FLIRZ 300.03
Dekorring weiß



FLIRZ 300.04
Lichteffektring opal



FLIRZ 300.05
Lichteffektring klar



FLIRZ 300.06
Lichteffektring rot matt



FLIRZ 300.07
Lichteffektring gelb matt



FLIRZ 300.08
Lichteffektring blau matt



FLIRZ 300.16
Lichteffektring rot transluzent



FLIRZ 300.17
Lichteffektring gelb transluzent



FLIRZ 300.18
Lichteffektring blau transluzent

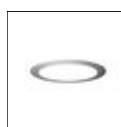

FLIRZ 300.24
Dekoglas opal



FLIRZ 300.25
Dekoglas klar



NOL 50B/3H/DALI
LED-Notlichteinheit



ZDAR 175.215-275
Ausgleichsring für Deckenausschnitte von 215 – 275 mm



ZVP 100
Universalverstärkungsrahmen
(Modul 625 x 625)