

# SCOUT 205.940.35.2

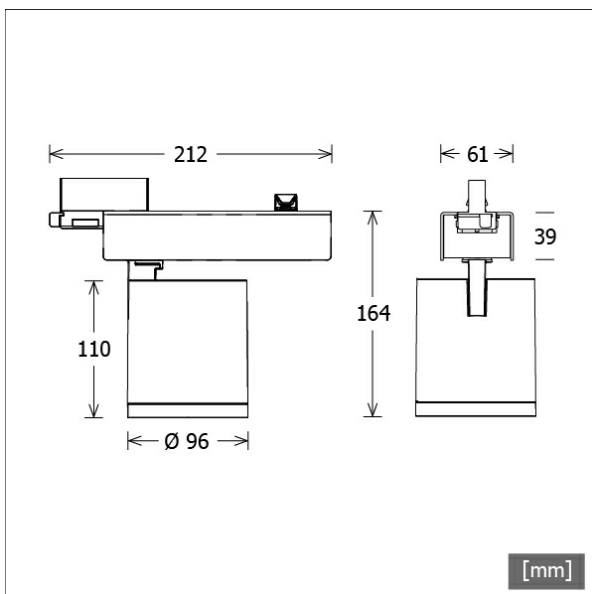

Farbe	Artikelnummer	EAN
silber	660643	4043544694690
schwarz	660644	4043544694706
weiß	660645	4043544694713



## Beschreibung

- flexibler Stromschienenstrahler in getrennter Bauform mit zylinderförmigem Lichtkopf
- Lichtkopf 355° drehbar und 90° schwenkbar über integrierten Gelenkarm
- hohe Wartungsfreundlichkeit
- keine UV- und Wärmestrahlung
- Lichtkopf aus Aluminiumdruckguss
- innovatives Wärmemanagement mit formintegrierter Passivkühlung
- High-Performance Spiegelreflektor aus Aluminium mit präziser symmetrischer Abstrahlcharakteristik für optimale Lichtausbeute und Entblendung
- Gehäuse für Betriebsgerät aus Aluminium
- reflektionsfreies EnergyVision Schutzglas klar
- 3-Phasen-Stromschienenadapter
- Betriebsgerät (LED-Konverter) integriert

## Standardoptionen



## Sonderoptionen



## Lichttechnik / Normen

Leuchtmittel	LED Spot / CRI 90 / 4000 K
EPREL Lichtquellen	848115
Lebensdauer	L90 B50 50.000 h
	L80 B50 100.000 h
	L80 B20 50.000 h
Systemleistung	45.8 W
Leuchten-Lichtstrom	5250 lm
Systemeffizienz	114.62 lm/W
Moduleffizienz	145.64 lm/W
UGR Klasse	≤22
Abstrahlwinkel	35°
Versorgungsspannung	220 - 240 V / 50 - 60 Hz
Schutzklasse	I
Schutzart	IP20

## Abmessungen / Gewichte

Länge	212 mm
Breite	96 mm
Höhe	164 mm
Durchmesser Lichtkopf	96 mm
Nettogewicht	1.16 kg
Bruttogewicht	1.23 kg

# SCOUT 205.940.35.2

Scout Next (1xLED 46W 940/4000K 5250lm 35°)

C0/C180 cd / 1000 lm

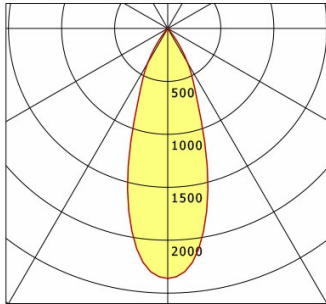

	C0	C90	C180	C270
0°	2362	2362	2362	2362
15°	1460	1460	1460	1460
30°	379	379	379	379
45°	12	12	12	12
60°	1	1	1	1
75°	0	0	0	0
90°	0	0	0	0
cd / 1000 lm				

Offset [m] Cone width [m] Illuminance [lx]

Offset [m]	Cone width [m]	Illuminance [lx]
3.0	1.89	1377.7
6.0	3.78	344.4
9.0	5.68	153.1
12.0	7.57	86.1
15.0	9.46	55.1

<b>η</b>	LED
Efficiency	114 lm/W
Direct/Indirect	↓ 100% / ↑ 0%
System Power	46 W
<b>UGR</b>	X=4H, Y=8H
Reflection factors	70/50/20
UGR C0/C180	19.9
UGR C90/C270	19.9
CIE Flux Codes	99 100 100 100 100
Ra/CRI	>90

LTS

## Zubehör



**EU 10**  
Anbau-Stromschiene Professional  
(Länge: 1000 mm)



**EU 20**  
Anbau-Stromschiene Professional  
(Länge: 2000 mm)



**EU 21**  
Anbau-Stromschiene Professional  
(Länge: 3000 mm)



**EU 22**  
Anbau-Stromschiene Professional  
(Länge: 4000 mm)



**EUE 20**  
Einbau-Stromschiene Professional  
(Länge: 2000 mm)



**EUE 21**  
Einbau-Stromschiene Professional  
(Länge: 3000 mm)



**EUE 22**  
Einbau-Stromschiene Professional  
(Länge: 4000 mm)



**LAB 60**  
3-Phasen-Einbau-Monopoint mit Busoption



**LAB 60 A**  
3-Phasen-Anbau-Monopoint mit Busoption



**ST-A 10/9000A-1-ST**  
Anbau-Stromschiene ONETrack Advance mit Datenbus  
(Länge: 1000 mm)



**ST-A 20/9000A-2-ST**  
Anbau-Stromschiene ONETrack Advance mit Datenbus  
(Länge: 2000 mm)



**ST-A 30/9000A-3-ST**  
Anbau-Stromschiene ONETrack Advance mit Datenbus  
(Länge: 3000 mm)

# SCOUT 205.940.35.2

## Zubehör



**ST-A 40/9000A-4-ST**  
Anbau-Stromschiene ONETrack Advance mit Datenbus  
(Länge: 4000 mm)



**ST-A MONO/9000-BPU-D**  
3-Phasen-Anbau-Monopoint mit Busoption



**ST-E 10/9000-1-R**  
Einbau-Stromschiene ONETrack mit Datenbus  
(Länge: 1000 mm)



**ST-E 20/9000-2-R**  
Einbau-Stromschiene ONETrack mit Datenbus  
(Länge: 2000 mm)



**ST-E 30/9000-3-R**  
Einbau-Stromschiene ONETrack mit Datenbus  
(Länge: 3000 mm)



**ST-E 40/9000-4-R**  
Einbau-Stromschiene ONETrack mit Datenbus  
(Länge: 4000 mm)



**ST-E MONO/9000-BPU-D**  
3-Phasen-Einbau-Monopoint mit Busoption



**ZBK 13**  
Blendklappe



**ZBW 87**  
Wabenraster