

# FLIR 200.2040.25/DALI

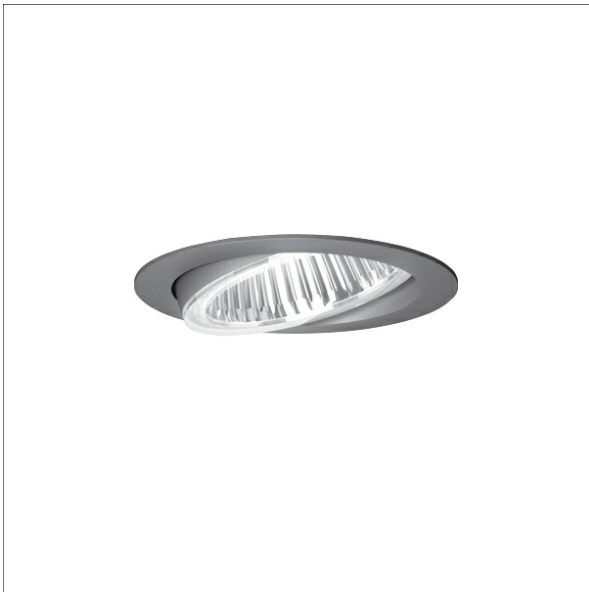

Farbe	Artikelnummer	EAN
schwarz	641762	4043544473080
silber	641763	4043544473097
weiß	641764	4043544473103

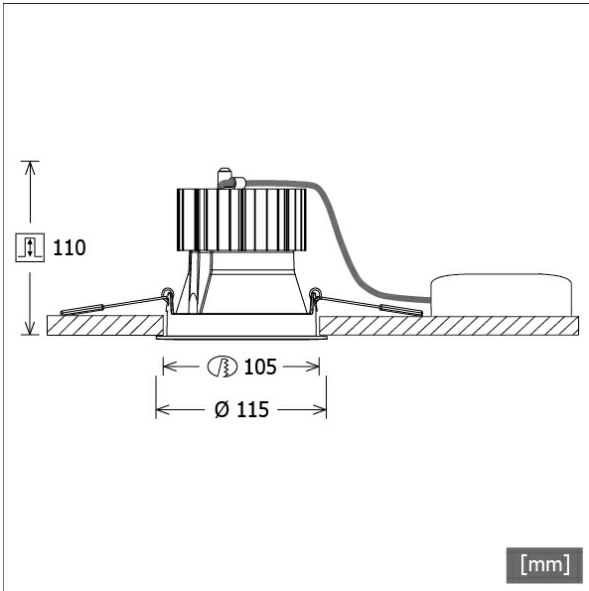

## Beschreibung

- Einbaustrahler mit optischen Designvarianten und breitem Anwendungsspektrum
- Lichtkopf 20° schwenkbar
- hohe Wartungsfreundlichkeit
- keine UV- und Wärmestrahlung
- Wärmemanagement mit Passivkühlung (Kühlkörper aus Aluminium)
- High-Performance Spiegelreflektor aus Aluminium mit präziser symmetrischer Abstrahlcharakteristik für maximale Lichtausbeute und optimale Entblendung
- Front-/Einbauring aus Zinkdruckguss mit Lichteffektring klar (weitere Dekor-/Lichteffektringe und Dekogläser sind als Option erhältlich)
- werkzeugloser Deckeneinbau mit Schnellspannfedern (automatische Anpassung der Deckenstärke)
- Anschluss an Betriebsgerät über Leuchtenkabel mit Mini-Clamp Steckverbindung
- Betriebsgerät (LED-Konverter DALI, dimmbar) inklusive (Platzierung extern)

## Standardoptionen

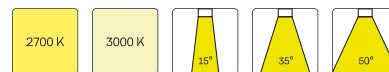

## Sonderoptionen



## Lichttechnik / Normen

Leuchtmittel	LED Spot / CRI 80 / 4000 K
EPREL Lichtquellen	848119
Lebensdauer	L90 B50 50.000 h L80 B50 100.000 h L80 B20 50.000 h
Systemleistung	27,0 W
Leuchten-Lichtstrom	max. 3110 lm
Systemeffizienz	115,18 lm/W
Moduleffizienz	160,37 lm/W
UGR Klasse	≤28
Abstrahlwinkel	25°
Versorgungsspannung	220 - 240 V / 50 - 60 Hz
Schutzklasse	III
Schutzart	IP20

## Abmessungen / Gewichte

Außendurchmesser	115 mm
Höhe	112 mm
Ausschnittsmaß (Ø)	105 mm
Deckenstärke	1,0 - 25,0 mm
Einbautiefe	110 mm
Nettogewicht	0,93 kg
Bruttogewicht	1,01 kg

# FLIR 200.2040.25/DALI

Flixx 200 Round (FLIRZ 200.05, 1xLED 27W 840/4000K 3110lm 15 °)

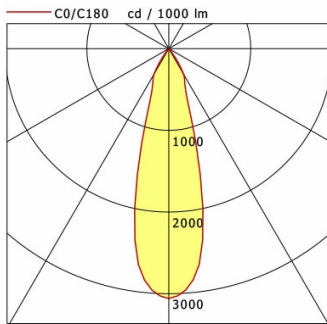

	C0	C90	C180	C270
0°	3059	3059	3059	3059
15°	1386	1386	1386	1386
30°	362	362	362	362
45°	16	16	16	16
60°	11	11	11	11
75°	5	5	5	5
90°	0	0	0	0
cd / 1000 lm				

Offset [m]	Cone width [m]	Illuminance [lx]
3.0	1.53	1057.1
6.0	3.06	264.3
9.0	4.59	117.5
12.0	6.12	66.1
15.0	7.65	42.3

<b>η</b>	LED
Efficiency	115 lm/W
Direct/Indirect	↓ 100% / ↑ 0%
System Power	27 W
<b>UGR</b>	X=4H, Y=8H
Reflection factors	70/50/20
UGR C0/C180	19.8
UGR C90/C270	19.8
CIE Flux Codes	96 98 100 100 100
Ra/CRI	>80

LTS

Flixx 200 Round (FLIRZ 200.24, 1xLED 27W 840/4000K 2930lm 15 °)

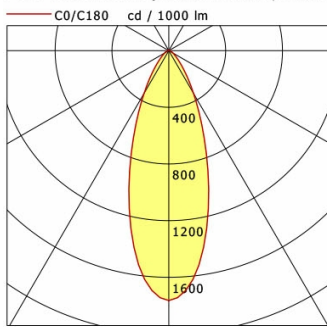

	C0	C90	C180	C270
0°	1764	1764	1764	1764
15°	1084	1084	1084	1084
30°	348	348	348	348
45°	95	95	95	95
60°	35	35	35	35
75°	14	14	14	14
90°	0	0	0	0
cd / 1000 lm				

Offset [m]	Cone width [m]	Illuminance [lx]
3.0	1.97	574.3
6.0	3.94	143.6
9.0	5.91	63.8
12.0	7.88	35.9
15.0	9.85	23.0

<b>η</b>	LED
Efficiency	109 lm/W
Direct/Indirect	↓ 100% / ↑ 0%
System Power	27 W
<b>UGR</b>	X=4H, Y=8H
Reflection factors	70/50/20
UGR C0/C180	25.8
UGR C90/C270	25.8
CIE Flux Codes	85 95 99 100 100
Ra/CRI	>80

LTS

Flixx 200 Round (FLIRZ 200.25, 1xLED 27W 840/4000K 3030lm 15 °)

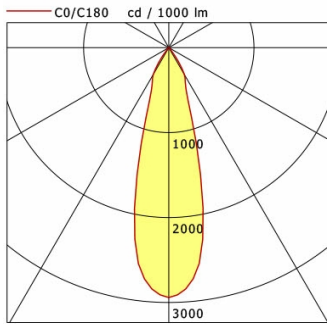

	C0	C90	C180	C270
0°	2942	2942	2942	2942
15°	1350	1350	1350	1350
30°	366	366	366	366
45°	19	19	19	19
60°	14	14	14	14
75°	4	4	4	4
90°	0	0	0	0
cd / 1000 lm				

Offset [m]	Cone width [m]	Illuminance [lx]
3.0	1.54	990.4
6.0	3.08	247.6
9.0	4.62	110.0
12.0	6.16	61.9
15.0	7.70	39.6

<b>η</b>	LED
Efficiency	112 lm/W
Direct/Indirect	↓ 100% / ↑ 0%
System Power	27 W
<b>UGR</b>	X=4H, Y=8H
Reflection factors	70/50/20
UGR C0/C180	20.1
UGR C90/C270	20.1
CIE Flux Codes	95 99 100 100 100
Ra/CRI	>80

LTS

# FLIRZ 200.2040.25/DALI

## Zubehör



**FLIRZ 200.01**  
Dekorring schwarz



**FLIRZ 200.02**  
Dekorring silber



**FLIRZ 200.03**  
Dekorring weiß



**FLIRZ 200.04**  
Lichteffektring opal



**FLIRZ 200.05**  
Lichteffektring klar



**FLIRZ 200.06**  
Lichteffektring rot matt



**FLIRZ 200.07**  
Lichteffektring gelb matt



**FLIRZ 200.08**  
Lichteffektring blau matt



**FLIRZ 200.16**  
Lichteffektring rot transluzent



**FLIRZ 200.17**  
Lichteffektring gelb transluzent



**FLIRZ 200.18**  
Lichteffektring blau transluzent

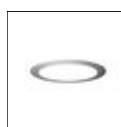

**FLIRZ 200.24**  
Dekoglas opal



**FLIRZ 200.25**  
Dekoglas klar