

# FLIR 100.1027.15/DALI

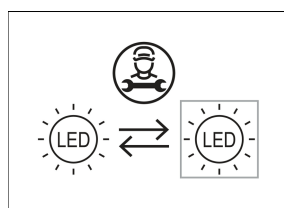

Farbe	Artikelnummer	EAN
schwarz	641711	4043544472571
silber	641712	4043544472588
weiß	641713	4043544472595

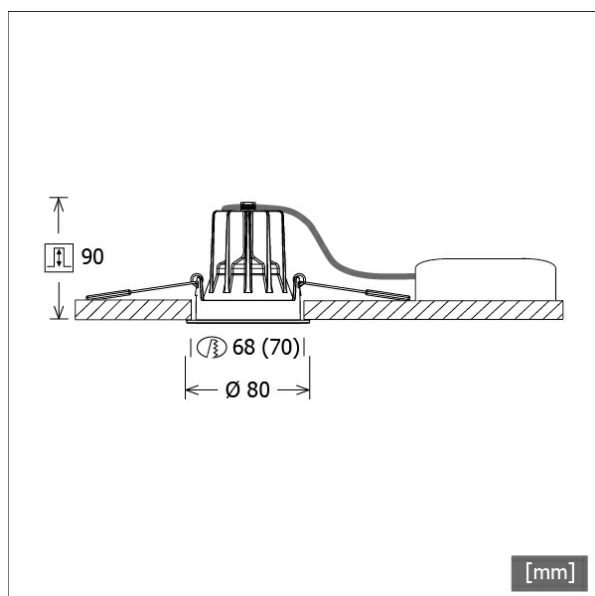

## Beschreibung

- Einbaustrahler mit optischen Designvarianten und breitem Anwendungsspektrum
- Lichtkopf 20° schwenkbar
- hohe Wartungsfreundlichkeit
- keine UV- und Wärmestrahlung
- innovatives Wärmemanagement mit Passivkühlung (Kühlkörper aus Aluminiumdruckguss)
- High-Performance Spiegelreflektor aus Aluminium mit präziser symmetrischer Abstrahlcharakteristik für maximale Lichtausbeute und optimale Entblendung
- Front-/Einbauring aus Zinkdruckguss mit Lichteffektring klar (weitere Dekor-/Lichteffektringe und Dekogläser sind als Option erhältlich)
- werkzeugloser Deckeneinbau mit Schnellspannfedern (automatische Anpassung der Deckenstärke)
- Anschluss an Betriebsgerät über Leuchtenkabel mit Mini-Clamp Steckverbindung
- Betriebsgerät (LED-Konverter DALI, dimmbar) inklusive (Platzierung extern)

## Hinweise

Das Aussägemeaß = 68 mm gilt nur für Gipskartondecken. Für andere Deckenarten gilt das Aussägemeaß = 70 mm.

## Standardoptionen

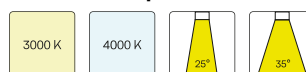

## Sonderoptionen



## Lichttechnik / Normen

Leuchtmittel	LED Spot / CRI 80 / 2700 K
EPREL Lichtquellen	988874
Lebensdauer	L90 B50 50.000 h L80 B50 100.000 h L80 B20 50.000 h
Systemleistung	15.0 W
Leuchten-Lichtstrom	max. 1310 lm
Systemeffizienz	87.33 lm/W
Moduleffizienz	128.77 lm/W
UGR Klasse	≤28
Abstrahlwinkel	15°
Versorgungsspannung	220 - 240 V / 50 - 60 Hz
Schutzklasse	III
Schutzart	IP20

## Abmessungen / Gewichte

Außendurchmesser	80 mm
Höhe	92 mm
Ausschnittsmaß (Ø)	68 mm
Deckenstärke	1.0 - 25.0 mm
Einbautiefe	90 mm
Nettogewicht	0.48 kg

Einbau-Downlights · Flixx 100 Round

FLIR 100.1027.15/DALI

Bruttogewicht



LTS  
LOVE TO SHINE

0.50 kg

# FLIR 100.1027.15/DALI

Flixx 100 Round (FLIRZ 100.05, 1xLED 15W 827/2700K 1310lm 15 °)

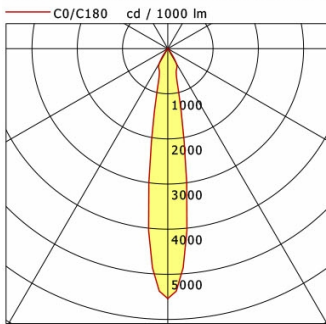

	C0	C90	C180	C270
0°	5537	5537	5537	5537
15°	842	842	842	842
30°	377	377	377	377
45°	30	30	30	30
60°	19	19	19	19
75°	9	9	9	9
90°	0	0	0	0
cd / 1000 lm				

Offset [m]	Cone width [m]	Illuminance [lx]
3.0	0.90	806.0
6.0	1.80	201.5
9.0	2.70	89.6
12.0	3.60	50.4
15.0	4.50	32.2

<b>η</b>	LED
Efficiency	88 lm/W
Direct/Indirect	↓ 100% / ↑ 0%
System Power	15 W
<b>UGR</b>	X=4H, Y=8H
Reflection factors	70/50/20
UGR C0/C180	22.2
UGR C90/C270	22.2
CIE Flux Codes	93 97 99 100 100
Ra/CRI	>80

LTS

Flixx 100 Round (FLIRZ 100.24, 1xLED 15W 827/2700K 1230lm 15 °)

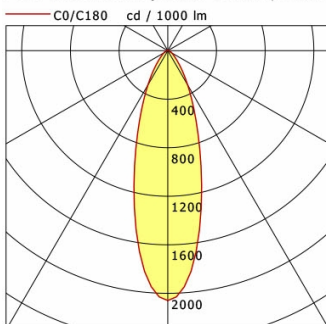

	C0	C90	C180	C270
0°	2059	2059	2059	2059
15°	1068	1068	1068	1068
30°	327	327	327	327
45°	96	96	96	96
60°	38	38	38	38
75°	17	17	17	17
90°	0	0	0	0
cd / 1000 lm				

Offset [m]	Cone width [m]	Illuminance [lx]
3.0	1.67	281.5
6.0	3.33	70.4
9.0	5.00	31.3
12.0	6.67	17.6
15.0	8.33	11.3

<b>η</b>	LED
Efficiency	82 lm/W
Direct/Indirect	↓ 100% / ↑ 0%
System Power	15 W
<b>UGR</b>	X=4H, Y=8H
Reflection factors	70/50/20
UGR C0/C180	26.3
UGR C90/C270	26.3
CIE Flux Codes	84 95 99 100 100
Ra/CRI	>80

LTS

Flixx 100 Round (FLIRZ 100.25, 1xLED 15W 827/2700K 1270lm 15 °)

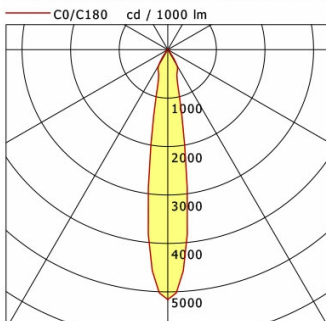

	C0	C90	C180	C270
0°	5158	5158	5158	5158
15°	842	842	842	842
30°	377	377	377	377
45°	34	34	34	34
60°	28	28	28	28
75°	8	8	8	8
90°	0	0	0	0
cd / 1000 lm				

Offset [m]	Cone width [m]	Illuminance [lx]
3.0	0.92	727.9
6.0	1.83	182.0
9.0	2.75	80.9
12.0	3.66	45.5
15.0	4.58	29.1

<b>η</b>	LED
Efficiency	85 lm/W
Direct/Indirect	↓ 100% / ↑ 0%
System Power	15 W
<b>UGR</b>	X=4H, Y=8H
Reflection factors	70/50/20
UGR C0/C180	22.5
UGR C90/C270	22.5
CIE Flux Codes	92 97 99 100 100
Ra/CRI	>80

LTS

# FLIR 100.1027.15/DALI

## Zubehör



**FLIRZ 100.01**  
Dekorring schwarz



**FLIRZ 100.02**  
Dekorring silber



**FLIRZ 100.03**  
Dekorring weiß



**FLIRZ 100.04**  
Lichteffektring opal



**FLIRZ 100.05**  
Lichteffektring klar



**FLIRZ 100.06**  
Lichteffektring rot matt



**FLIRZ 100.07**  
Lichteffektring gelb matt



**FLIRZ 100.08**  
Lichteffektring blau matt



**FLIRZ 100.16**  
Lichteffektring rot transluzent



**FLIRZ 100.17**  
Lichteffektring gelb transluzent



**FLIRZ 100.18**  
Lichteffektring blau transluzent

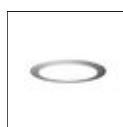

**FLIRZ 100.24**  
Dekoglas opal



**FLIRZ 100.25**  
Dekoglas klar