

# LUZ-TZ32 110.840.60



## Beschreibung

- Stromschienenleuchte in rechteckigem Design mit drehbarem Zentraladapter für vielfältige Beleuchtungsaufgaben
- symmetrisch und breitstrahlende Lichtverteilung (Abstrahlwinkel 60°)
- hohe Wartungsfreundlichkeit
- keine UV- und Wärmestrahlung
- Gehäuse aus Stahlblech
- vorgesetzte Linsenoptik aus PMMA matt
- 3-Phasen-Stromschienenadapter
- Betriebsgerät (LED-Konverter) integriert

## Standardoptionen



## Sonderoptionen



Farbe	Artikelnummer	EAN
silber	667531	4043544768285
schwarz	667532	4043544768292
weiß	667533	4043544768308

## Lichttechnik / Normen

Leuchtmittel	LED Modul / CRI 80 / 4000 K
Lebensdauer	L90 B50 50.000 h L80 B50 100.000 h L80 B20 50.000 h
Systemleistung	64.8 W
Leuchten-Lichtstrom	10140 lm
Systemeffizienz	156.48 lm/W
Moduleffizienz	168.00 lm/W
UGR Klasse	≤25
Abstrahlwinkel	60°
Versorgungsspannung	220 - 240 V / 50 - 60 Hz
Schutzklasse	I
Schutzart	IP20

## Abmessungen / Gewichte

Länge	587 mm
Breite	193 mm
Höhe	62 mm
Nettogewicht	2.65 kg
Bruttogewicht	2.80 kg

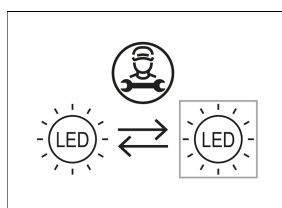
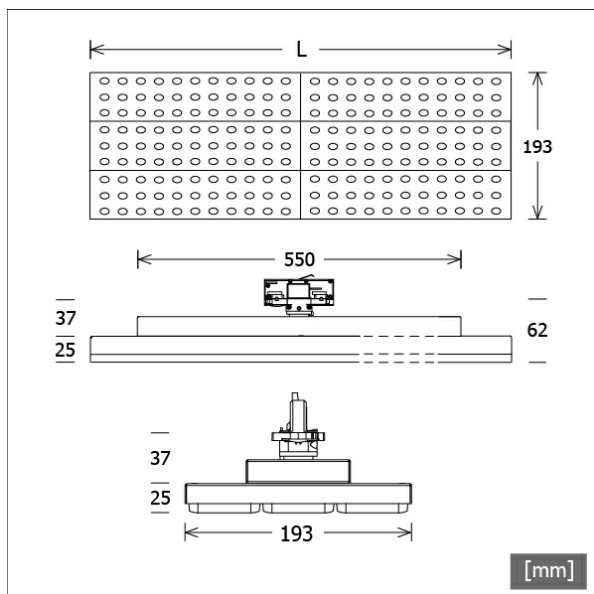

# LUZ-TZ32 110.840.60

## LUZ-TZ32 110.840.60

LUZ | Track-Mounted Central Adapter (1xLED 65W 840/4000K 10140lm 60°)

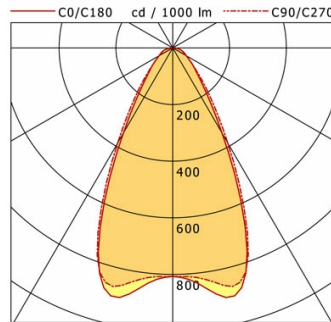

	C0	C90	C180	C270
0°	807	807	807	807
15°	895	868	895	868
30°	347	388	347	388
45°	115	125	115	125
60°	55	55	55	55
75°	32	28	32	28
90°	5	2	5	2
cd / 1000 lm				

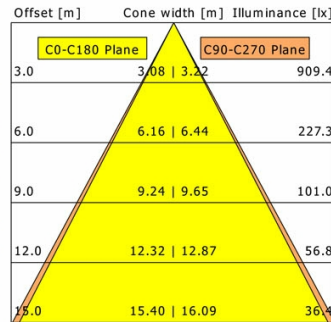

<b>η</b>	LED
Efficiency	156 lm/W
Direct/Indirect	↓ 99% / ↑ 1%
System Power	65 W
<b>UGR</b>	X=4H, Y=8H
Reflection factors	70/50/20
UGR C0/C180	22.9
UGR C90/C270	22.7
CIE Flux Codes	76 90 97 99 100
Ra/CRI	>80

LTS

### Zubehör



**EU 10**  
Anbau-Stromschiene Professional  
(Länge: 1000 mm)



**EU 20**  
Anbau-Stromschiene Professional  
(Länge: 2000 mm)



**EU 21**  
Anbau-Stromschiene Professional  
(Länge: 3000 mm)



**EU 22**  
Anbau-Stromschiene Professional  
(Länge: 4000 mm)



**EUE 20**  
Einbau-Stromschiene Professional  
(Länge: 2000 mm)



**EUE 21**  
Einbau-Stromschiene Professional  
(Länge: 3000 mm)



**EUE 22**  
Einbau-Stromschiene Professional  
(Länge: 4000 mm)



**ST-A 10/9000-1-ST**  
Anbau-Stromschiene ONETrack mit Datenbus  
(Länge: 1000 mm)



**ST-A 10/9000A-1-ST**  
Anbau-Stromschiene ONETrack Advance mit Datenbus  
(Länge: 1000 mm)



**ST-A 20/9000-2-ST**  
Anbau-Stromschiene ONETrack mit Datenbus  
(Länge: 2000 mm)



**ST-A 20/9000A-2-ST**  
Anbau-Stromschiene ONETrack Advance mit Datenbus  
(Länge: 2000 mm)



**ST-A 30/9000-3-ST**  
Anbau-Stromschiene ONETrack mit Datenbus  
(Länge: 3000 mm)

# LUZ-TZ32 110.840.60

## Zubehör



**ST-A 30/9000A-3-ST**  
Anbau-Stromschiene ONETrack Advance mit Datenbus  
(Länge: 3000 mm)



**ST-A 40/9000-4-ST**  
Anbau-Stromschiene ONETrack mit Datenbus  
(Länge: 4000 mm)



**ST-A 40/9000A-4-ST**  
Anbau-Stromschiene ONETrack Advance mit Datenbus  
(Länge: 4000 mm)



**ST-E 10/9000-1-R**  
Einbau-Stromschiene ONETrack mit Datenbus  
(Länge: 1000 mm)



**ST-E 20/9000-2-R**  
Einbau-Stromschiene ONETrack mit Datenbus  
(Länge: 2000 mm)



**ST-E 30/9000-3-R**  
Einbau-Stromschiene ONETrack mit Datenbus  
(Länge: 3000 mm)



**ST-E 40/9000-4-R**  
Einbau-Stromschiene ONETrack mit Datenbus  
(Länge: 4000 mm)