

FLIQ 300.3040.01

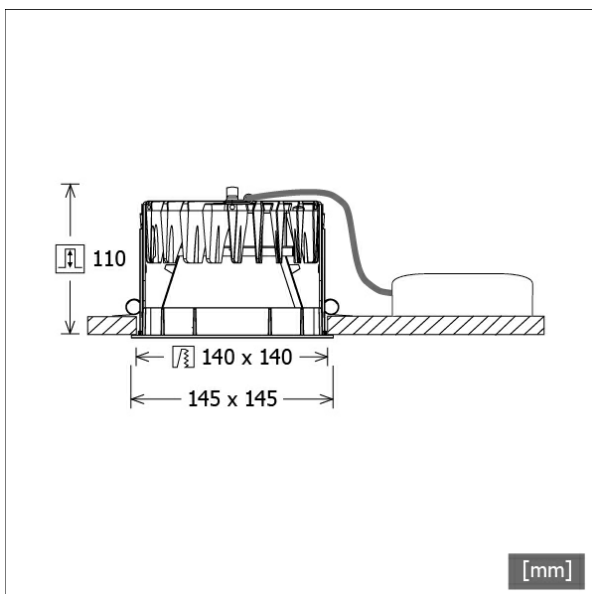

Farbe	Artikelnummer	EAN
schwarz	636462	4043544390448
silber	636463	4043544390455
weiß	636464	4043544390462



Beschreibung

- Einbau-Downlight mit optischen Designvarianten für Allgemeinbeleuchtung
- hohe Wartungsfreundlichkeit
- keine UV- und Wärmestrahlung
- innovatives Wärmemanagement mit Passivkühlung (Kühlkörper aus Aluminiumdruckguss)
- entspiegelter Mattreflektor aus Aluminium für maximale Lichtausbeute und optimale Entblendung
- Front-/Einbaurahmen aus Zinkdruckguss mit Lichteckrahmen klar (weitere Dekor-/Lichteckrahmen und Dekogläser sind als Option erhältlich)
- werkzeugloser Deckeneinbau mit Schnellspannautomatik (automatische Anpassung der Deckenstärke)
- Anschluss an Betriebsgerät über vormontiertes Leuchtenkabel
- Betriebsgerät (LED-Konverter) inklusive (Platzierung extern)

Standardoptionen



Sonderoptionen



Lichttechnik / Normen

Leuchtmittel	LED Modul / CRI80 / 4000 K
EPREL Lichtquellen	891013
Lebensdauer	L90 B50 50.000 h L80 B50 100.000 h L80 B20 50.000 h
Systemleistung	26.0 W
Leuchten-Lichtstrom	max. 2860 lm
Systemeffizienz	110.00 lm/W
Moduleffizienz	175.56 lm/W
UGR Klasse	≤25
Versorgungsspannung	220 - 240 V / 50 - 60 Hz
Schutzklasse	III
Schutzart	IP20

Abmessungen / Gewichte

Länge	145 mm
Breite	145 mm
Höhe	112 mm
Ausschnittsmaß (LxB))	140 x 140 mm
Deckenstärke	5.0 - 50.0 mm
Einbautiefe	110 mm
Nettogewicht	1.01 kg
Bruttogewicht	1.07 kg

FLIQ 300.3040.01

Flixx 300 Square (FLIQZ 300.05, 1xLED 26W 840/4000K 2860lm)

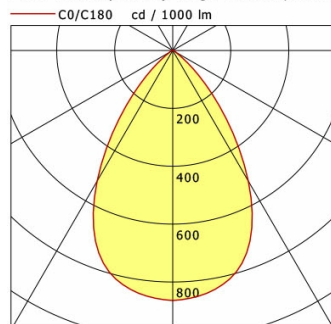

	C0	C90	C180	C270
0°	864	864	864	864
15°	805	805	805	805
30°	521	521	521	521
45°	144	144	144	144
60°	13	13	13	13
75°	7	7	7	7
90°	0	0	0	0

cd / 1000 lm

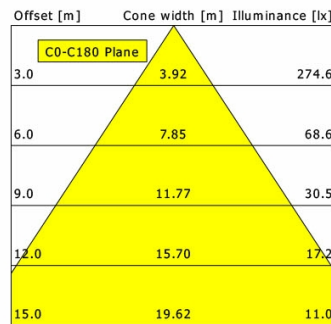

η	LED
Efficiency	110 lm/W
Direct/Indirect	↓ 100% / ↑ 0%
System Power	26 W
UGR	X=4H, Y=8H
Reflection factors	70/50/20
UGR C0/C180	21.5
UGR C90/C270	21.5
CIE Flux Codes	86 98 99 100 100
Ra/CRI	>80

LTS

Flixx 300 Square (FLIQZ 300.24, 1xLED 26W 840/4000K 2760lm)

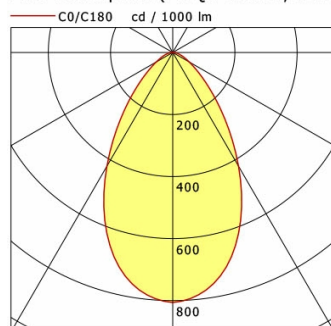

	C0	C90	C180	C270
0°	806	806	806	806
15°	699	699	699	699
30°	423	423	423	423
45°	173	173	173	173
60°	61	61	61	61
75°	22	22	22	22
90°	0	0	0	0

cd / 1000 lm

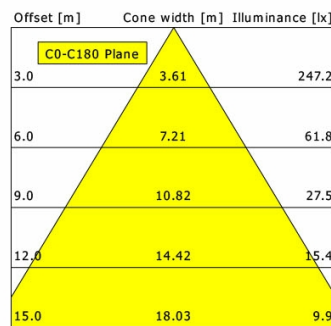

η	LED
Efficiency	106 lm/W
Direct/Indirect	↓ 100% / ↑ 0%
System Power	26 W
UGR	X=4H, Y=8H
Reflection factors	70/50/20
UGR C0/C180	25.2
UGR C90/C270	25.2
CIE Flux Codes	74 93 98 100 100
Ra/CRI	>80

LTS

Flixx 300 Square (FLIQZ 300.25, 1xLED 26W 840/4000K 2820lm)

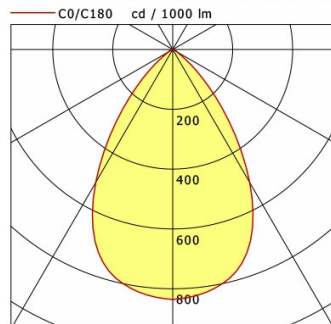

	C0	C90	C180	C270
0°	836	836	836	836
15°	780	780	780	780
30°	514	514	514	514
45°	155	155	155	155
60°	18	18	18	18
75°	6	6	6	6
90°	0	0	0	0

cd / 1000 lm

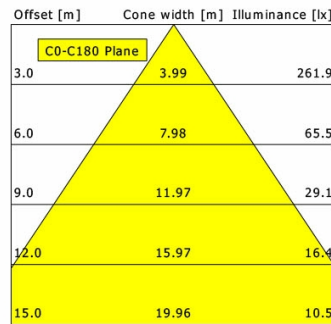

η	LED
Efficiency	108 lm/W
Direct/Indirect	↓ 100% / ↑ 0%
System Power	26 W
UGR	X=4H, Y=8H
Reflection factors	70/50/20
UGR C0/C180	21.7
UGR C90/C270	21.7
CIE Flux Codes	85 98 100 100 100
Ra/CRI	>80

LTS

FLIQ 300.3040.01

Zubehör



FLIQZ 300.01
Dekorrahmen schwarz



FLIQZ 300.02
Dekorrahmen silber



FLIQZ 300.03
Dekorrahmen weiß



FLIQZ 300.04
Lichteffektrahmen opal



FLIQZ 300.05
Lichteffektrahmen klar



FLIQZ 300.06
Lichteffektrahmen rot matt



FLIQZ 300.07
Lichteffektrahmen gelb matt



FLIQZ 300.08
Lichteffektrahmen blau matt



FLIQZ 300.16
Lichteffektrahmen rot transluzent



FLIQZ 300.17
Lichteffektrahmen gelb transluzent



FLIQZ 300.18
Lichteffektrahmen blau transluzent



FLIQZ 300.24
Dekoglas opal



FLIQZ 300.25
Dekoglas klar



NOL 50B/3H/DALI
LED-Notlichteinheit



ZVP 100
Universalverstärkungsrahmen
(Modul 625 x 625)