

Datenblatt

Bestell-Nr.: 13703

Anbausteckdose Quick-Connect gerade

Ampere	32A
Polzahl	3p (2P+PE)
Uhrzeitstellung	6h
Spannung	200 bis 250V
Frequenz	50 und 60Hz
Schutzart	IP44
Kennfarbe	blau RAL 5010
Anschlußtechnik	schraublose QUICK-CONNECT Anschlusstechnik
Kontaktträger	aus Polyamid, die Kontakte sind Messing blank
Gehäusematerial	Polyamid

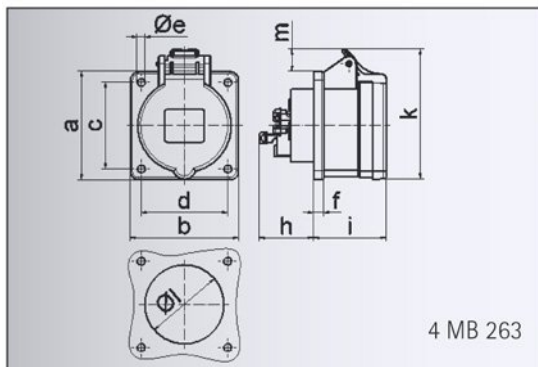

Ampere	16	16	16	32	32	32
Polzahl	3	4	5	3	4	5
a	75,0	75,0	75,0	75,0	75,0	75,0
b	75,0	75,0	75,0	75,0	75,0	75,0
c	60,0	60,0	60,0	60,0	60,0	60,0
d	60,0	60,0	60,0	60,0	60,0	60,0
e ø	5,5	5,5	5,5	5,5	5,5	5,5
f	7,0	7,0	7,0	8,0	8,0	8,0
h	35,5	35,5	35,5	50,0	50,0	50,0
i	50,0	50,0	51,0	60,0	60,0	60,0
k	74,0	84,0	91,0	94,0	94,0	102,0
l ø	45,0	45,0	55,0	60,0	60,0	60,0
m	8,0	12,0	16,0	17,0	17,0	22,0
Leiter mm ² min	1,5	1,5	1,5	2,5	2,5	2,5
Leiter mm ² max	4	4	4	10	10	10