

Datenblatt

Bestell-Nr.: 12931

Anbausteckdose Quick-Connect mit Neigung

Ampere	32A
Polzahl	4p (3P+PE)
Uhrzeitstellung	7h
Spannung	480 bis 500V
Frequenz	50 und 60Hz
Schutzart	IP67
Kennfarbe	schwarz RAL 9011
Anschlußtechnik	schraublose QUICK-CONNECT Anschlusstechnik
Kontaktträger	aus Polyamid, die Kontakte sind Messing blank
Gehäusematerial	Polyamid

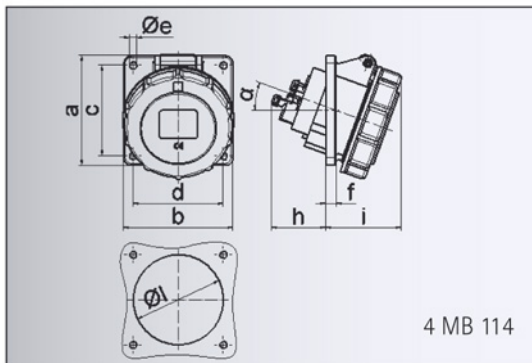

Ampere	16	16	16	32	32	32
Polzahl	3	4	5	3	4	5
a	85,0	85,0	85,0	85,0	85,0	85,0
b	85,0	85,0	85,0	85,0	85,0	85,0
c	70,0	70,0	70,0	70,0	70,0	70,0
d	70,0	70,0	70,0	70,0	70,0	70,0
e ø	5,5	5,5	5,5	5,5	5,5	5,5
f	8,0	8,0	8,0	8,0	8,0	8,0
h	46,0	46,0	46,0	61,0	61,0	61,0
i	57,0	57,0	60,0	65,0	65,0	69,0
l ø	57,0	65,0	70,0	78,0	78,0	78,0
α	20°	20°	20°	20°	20°	20°
Leiter mm ² min	1,5	1,5	1,5	2,5	2,5	2,5
Leiter mm ² max	4	4	4	10	10	10