

# Datenblatt

Bestell-Nr.: 12821

Anbausteckdose Quick-Connect mit Neigung

Ampere	<b>32A</b>
Polzahl	<b>4p (3P+PE)</b>
Uhrzeitstellung	<b>6h</b>
Spannung	<b>380 bis 415V</b>
Frequenz	<b>50 und 60Hz</b>
Schutzart	<b>IP67</b>
Kennfarbe	<b>rot RAL 3000</b>
Anschlußtechnik	<b>schraublose QUICK-CONNECT Anschlusstechnik</b>
Kontaktträger	<b>aus Polyamid, die Kontakte sind Messing blank</b>
Gehäusematerial	<b>Polyamid</b>

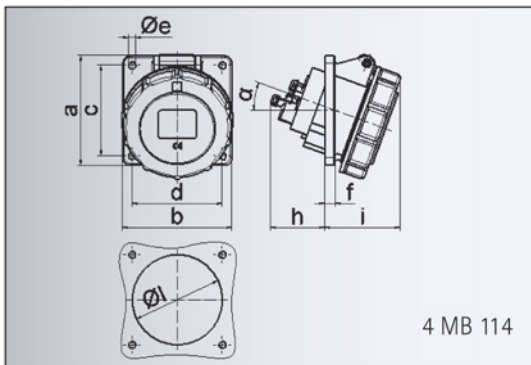

Ampere	16	16	16	32	32	32
Polzahl	3	4	5	3	4	5
a	85,0	85,0	85,0	85,0	85,0	85,0
b	85,0	85,0	85,0	85,0	85,0	85,0
c	70,0	70,0	70,0	70,0	70,0	70,0
d	70,0	70,0	70,0	70,0	70,0	70,0
e ø	5,5	5,5	5,5	5,5	5,5	5,5
f	8,0	8,0	8,0	8,0	8,0	8,0
h	46,0	46,0	46,0	61,0	61,0	61,0
i	57,0	57,0	60,0	65,0	65,0	69,0
l ø	57,0	65,0	70,0	78,0	78,0	78,0
α	20°	20°	20°	20°	20°	20°
Leiter mm <sup>2</sup> min	1,5	1,5	1,5	2,5	2,5	2,5
Leiter mm <sup>2</sup> max	4	4	4	10	10	10